

DIGITUS® Universal LED/LCD Monitor Wall Mount

DA-90357

EAN 4016032382706

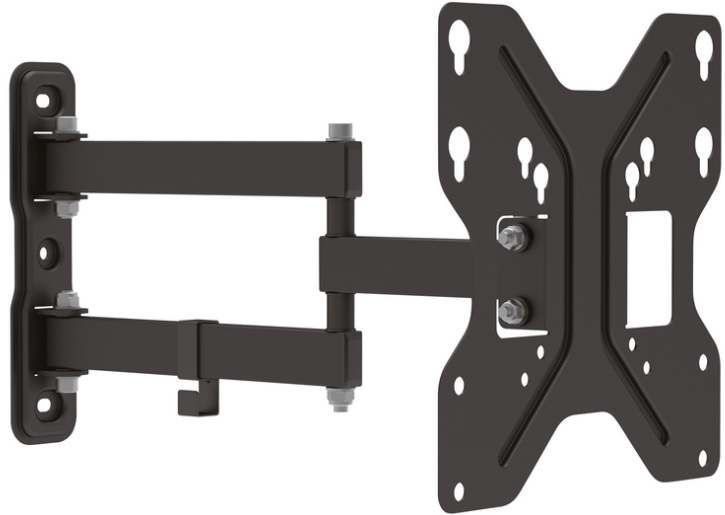

3D Universal TV/Monitor Mount up to 107cm (42") 15° Tilt, 180° Swivel, max 30kg, VESA max 200x200

Universal wall mount for flexibly aligning the monitor according to your viewing position with three adjustable levels. The universal wall mount allows you to install LED and LCD monitors and TVs of all brands, in sizes up to 107 cm. Simply note the VESA size and the weight of your monitor in order to select an appropriate wall mount.

Universal wall mount with adjustment options in all three dimensions

- Suitable for standard VESA mounting patterns of 75 x 75, 100 x 100, 200 x 100, and 200 x 200 mm.
- For mounting devices with a screen diagonal of 48 cm (19") to 107 cm (42") to the wall

- Max. load bearing capacity: 30 kg
- Weight: 1.7 kg

Attributes

- Monitor weight (max.): 30 kg
- Mounting method: Wall-mount
- Number of monitors: 1
- VESA mount: 200x200 mm

Package contents

- TV wall mount
- Screws for mounting the monitor
- Manual

Logistics						
	Number (pcs)	Weight (kg)	Depth (cm)	Width (cm)	Height (cm)	cm ³
Packaging Unit Carton	7	16.40	28.00	47.00	26.50	34,874.00
Packaging Unit Inside	1	2.34	0.00	0.00	0.00	0.00
Packaging Unit Single	1	2.34	24.50	26.50	6.30	4,090.27
Net single without Packaging	1	1.97	24.50	26.50	6.30	4,090.27

More images:

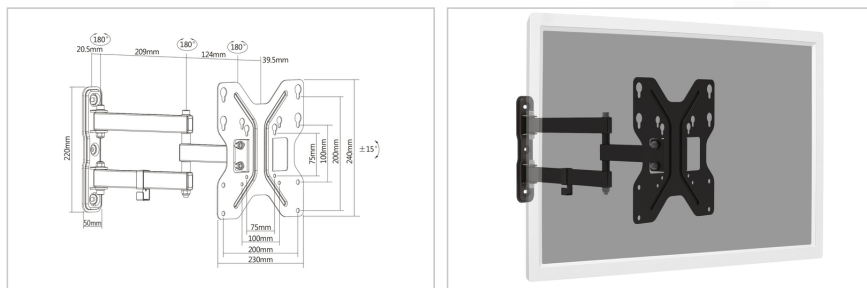

Safety notes

- Please read the entire manual before starting assembly and installation. Please contact your local dealer if you have any questions about the instructions or warnings.
- CAUTION: Use with products that exceed the permitted weight may result in damage or possible injury.
- Brackets should be fitted in accordance with the installation instructions. Incorrect installation can result in damage or injury.
- Use safety equipment and suitable tools. The product should only be installed by specialists.
- This product can be installed on timber-framed, solid concrete or stone walls.
- The load-bearing surfaces should be able to safely withstand the entire weight of appliances and all additional components.
- Only use the installation screws supplied and DO NOT TIGHTEN the screws TOO TIGHT.
- This product contains small parts that can cause a choking hazard if swallowed. Keep these parts away from children.
- Only use this product indoors. Using the product outdoors can lead to injuries and damage.
- IMPORTANT: Before installation, please check all components received against the components list. If parts are damaged or missing, ask your local dealer for replacement parts.
- MAINTENANCE: Check the bracket regularly for safety and stability (preferably every three months).

EU responsible person

EU based economic operator ensuring the product complies with the required regulations.

ASSMANN Electronic GmbH
 Auf dem Schüffel 3
 Lüdenscheid, Germany
<https://www.assmann.com>
info@assmann.com